

lame AS120

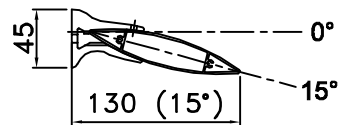

lame AS150L

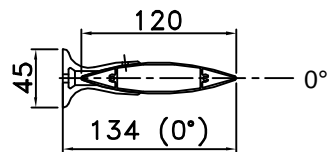
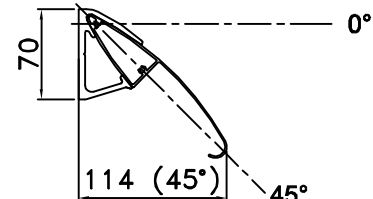
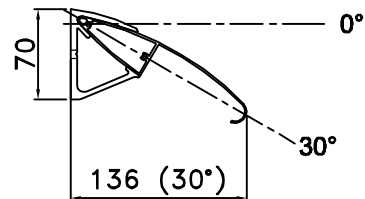
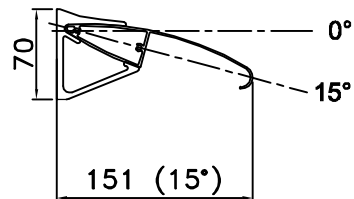
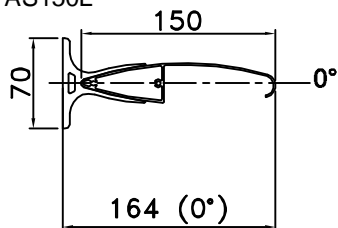

lame AS160

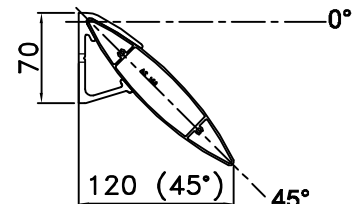
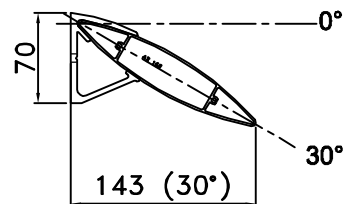
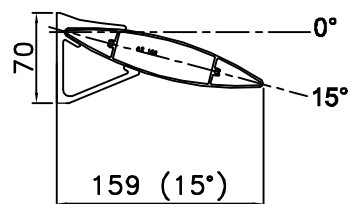
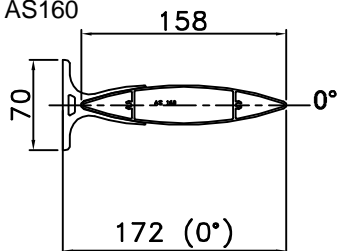

lame AS200

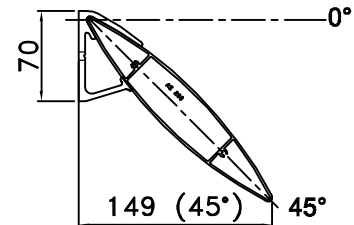
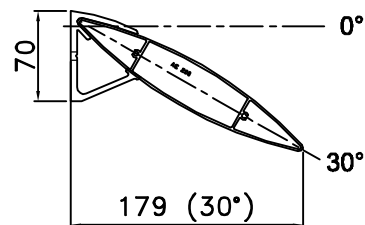
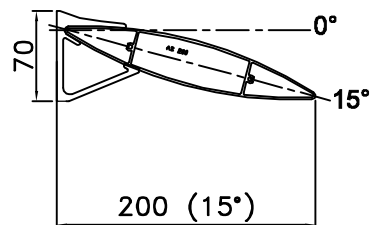
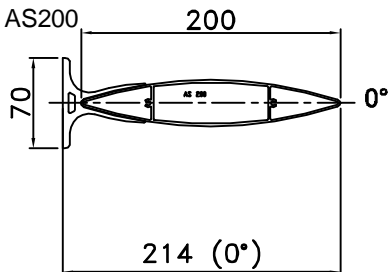

lame AS300

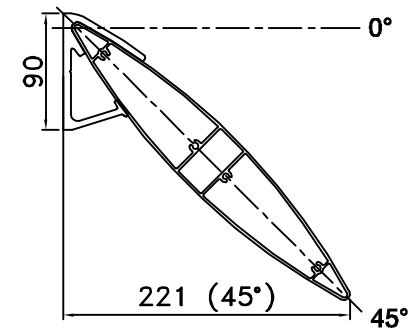
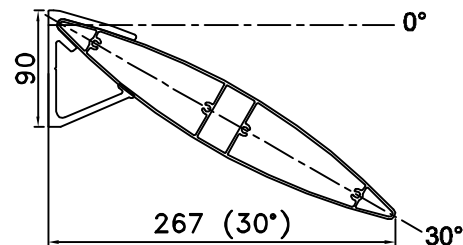
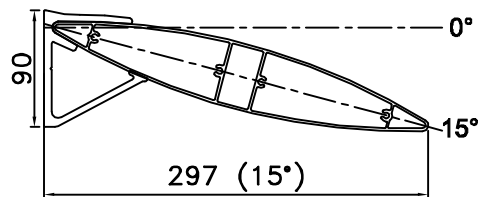
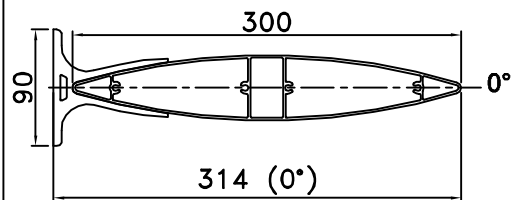

lame AS360

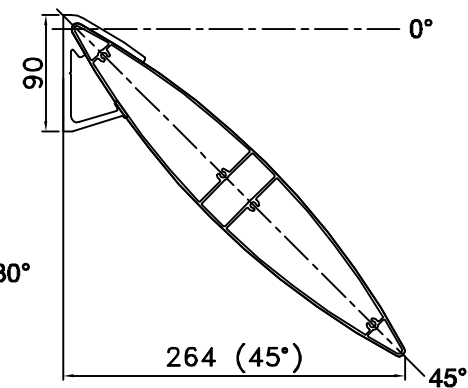
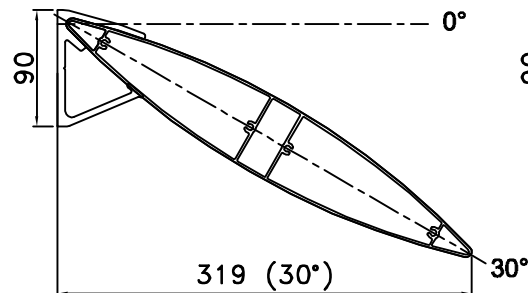
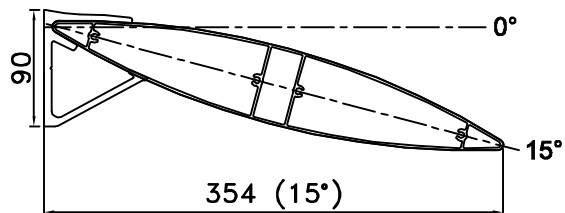
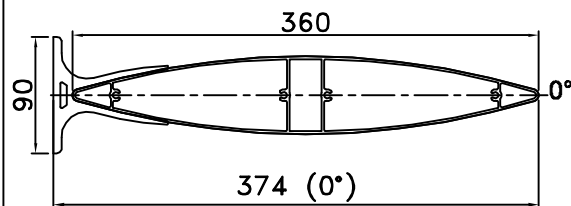

lame AS400

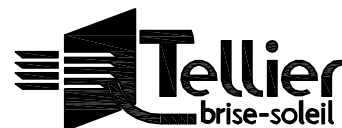
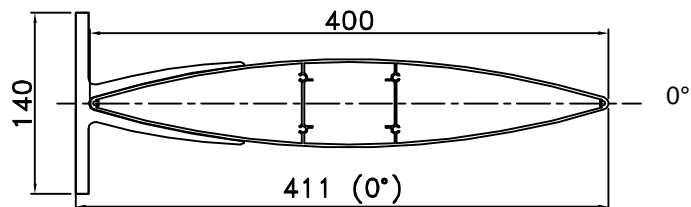

Anjou Actiparc des Trois Routes
49120 CHEMILLE

Tél : 02 41 30 45 45

Fax : 02 41 64 02 02

Site : www.tellier-g.com

E mail : brisesoleil@tellier-g.com

GAMME AZUR

ECH: - 02/03/2010

N° 10 XXX - 700

Indice

03

DESIGNATION ENCOMBREMENT LAME AZUR MONTAGE SPEED FIX

format A1