

COUPE VERTICALE

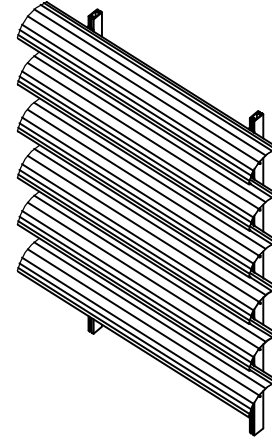

LAME C180

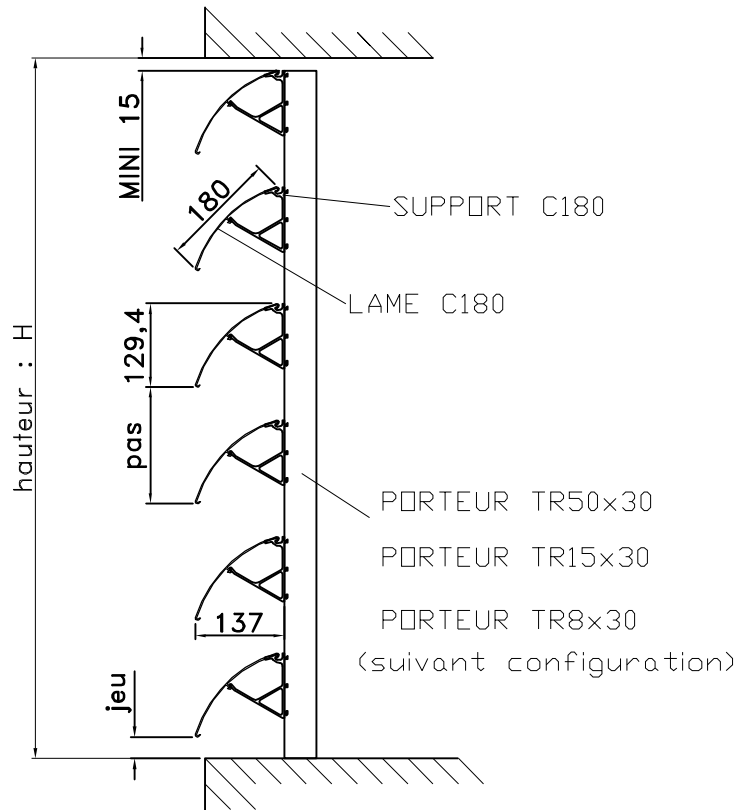
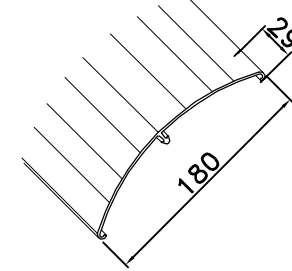

SUPPORT C180

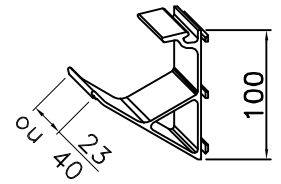

PORTEUR TR50x30

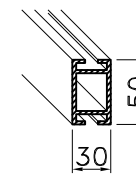

PORTEUR TR15x30

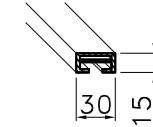

PORTEUR TR8x30

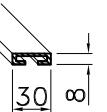

VUE EN PLAN

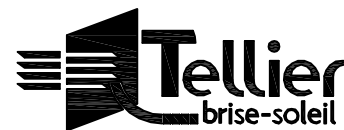
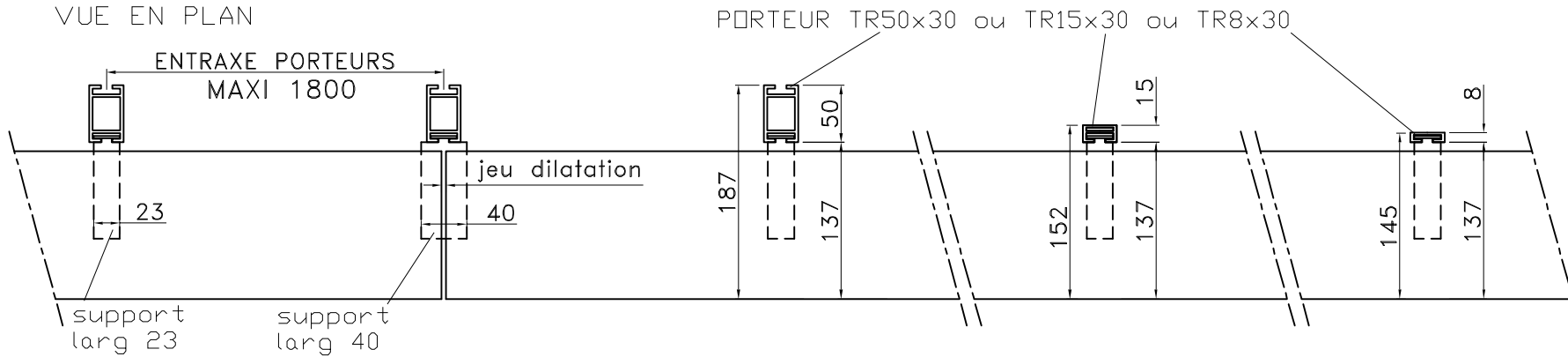

Anjou Actiparc des Trois Routes
49120 CHEMILLE

Tél : 02 41 30 45 45

Fax : 02 41 64 02 02

Site : www.tellier-g.com

E mail : brisesoleil@tellier-g.com

GAMME CANICULE C180

ECH:

19/10/2010

N° 20 180 - 500

Page

01

DESIGNATION

POSE C180 PORTEUR VERTICAL

format A1