

FIXATION PORTEUR

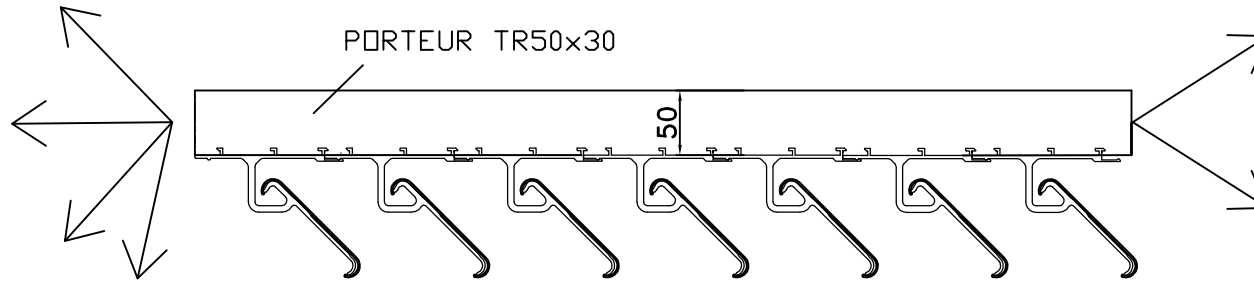

TERMINAISON TR50x30
AVEC BOUCHON

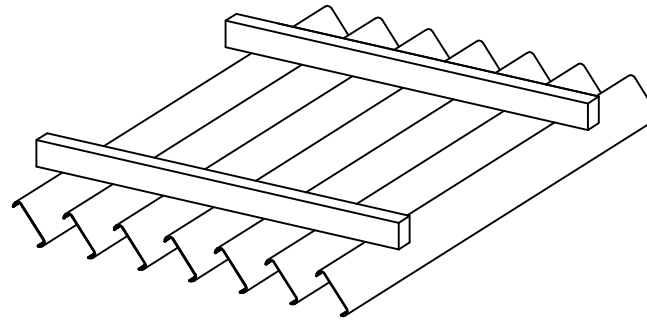
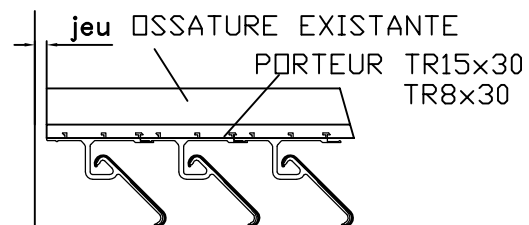
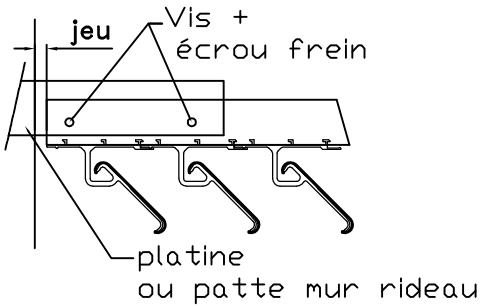
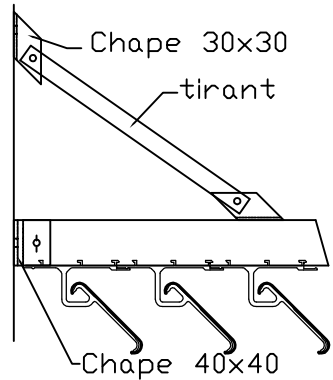
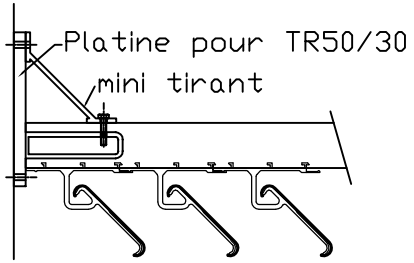
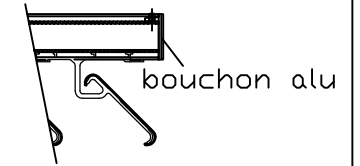

TERMINAISON TR50x30
AVEC BANDEAU

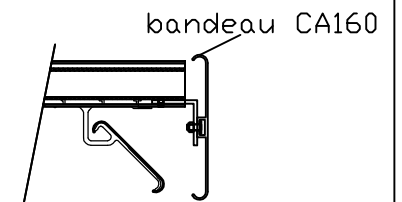

BANDEAU
CA160

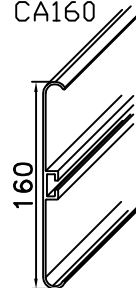

LAME CA100

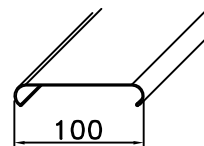

SUPPORT C100

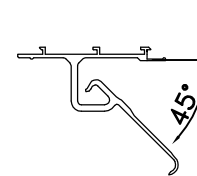

PORTEUR
TR50x30

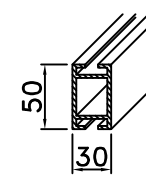

PORTEUR
TR15x30

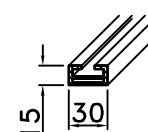

PORTEUR
TR8x30

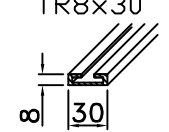

DESIGNATION PORTEUR HORIZONTAL LAME DESSOUS

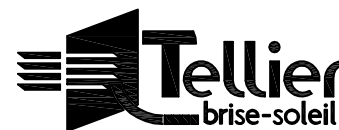

E mail : brisesoleil@tellier-g.com

Anjou Actiparc des Trois Routes
49120 CHEMILLE

Tél : 02 41 30 45 45

Fax : 02 41 64 02 02

Site : www.tellier-g.com

GAMME CANICULE CA100

ECH: 1/2

09/11/2010

N° 20 100 - 601

Page

01

format A1